

Q EXTRA 300G2

Day & Night Versions



SUPER PNP
Instruction Manual





BEFORE CONTINUING WITH THIS INSTRUCTION MANUAL OR ASSEMBLY OF YOUR AIRCRAFT, PLEASE VISIT OUR WIKI SUPPORT SITE FOR THE LATEST PRODUCT UPDATES, FEATURE CHANGES, MANUAL ADDENDUMS AND FIRMWARE CHANGES FOR BOTH YOUR AIRCRAFT AND THE INSTALLED ELECTRONICS.

**wiki.flexinnovations.com/wiki/QQExtra300G2
wiki.flexinnovations.com/wiki/Aura**

TABLE OF CONTENTS

Introduction	2	Receiver Installation/Servo Connections	10-12
Box Contents	2	Horizontal Stabilizer Installation	13
Specifications	3	Main Wing Installation	14
Replacement Parts	3	SFG Installation	15
Optional Accessories	3	Battery Installation	16
Completion Items	3	Transmitter Control Direction Test	17
Battery Charging Guidelines	3	Aura 8 Sensor Direction Test	18
Special Language Definitions	4	Propeller and Spinner Installation	19
Important Information Regarding Warranty	4	Center of Gravity	20
Safety Warnings and Precautions	4	Pre-Flight Checks	20
Low Voltage Cutoff	4	Flying your QQ Extra 300G2	21
Main Landing Gear Installation	5	Airframe Repairs	22
Optional Wheel Pant Removal	6	Replacing Servos	22
Tailwheel Installation	6	Servicing the Power System	23
Aura 8 AFCS	7	Aircraft Troubleshooting Guide	24
Transmitter Setup	8	Limited Warranty	25
Connecting a Battery/Arming the ESC	9	AMA Safety Code	26

INTRODUCTION

The perfect first 3D aerobat!

The QQ Extra 300G2 is the evolution and accumulation of many years of design experience. A perfectly balanced airframe design combined with today's most advanced control system gives an unmatched flying experience. Pilots will feel smooth, precise aircraft control without any interference to pilot inputs. The aircraft will fly as if it were much larger, turbulent air will be less noticeable, rotations will stop more precisely and landing will be easier to execute.

The Generation 2 (G2) QQ Extra 300 takes the original experience to the next level, by including a more powerful power system, new servos, new Aura 8 Firmware with bounceback control and much more!

For the latest updates, features, addendums and more, before assembly, please visit:

wiki.flexinnovations.com/wiki/QQExtra300G2

wiki.flexinnovations.com/wiki/Aura

- Pre-installed and custom-tuned Aura 8 Advanced Flight Control System with bounceback control
- Updated 1400kv motor and 50A ESC for more power
- (4) High-Precision Potenza DS-15 servos
- Light wing loading for easy handling
- 3-6 minute flight times depending on battery choice and throttle management
- Designed around the popular 3S 2200mAh battery
- Light Weight EPO foam that is durable and easy to repair
- Night version now includes LEDs in the fuselage

BOX CONTENTS



SPECIFICATIONS

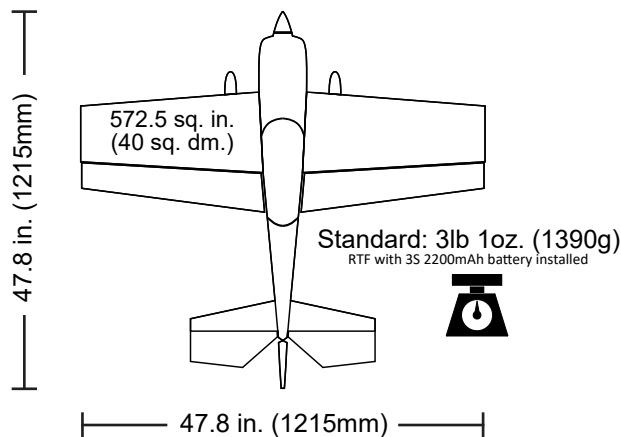

REPLACEMENT PARTS

FPM307001	Fuselage (Day)
FPM378001	Fuselage (Night)
FPM307002	Wing Set (Day) with SFGs
FPM378002	Wing Set (Night) with SFGs
FPM307003	Tail Set with Rudder
FPM307004	Cowling and Hatch Set
FPM307005	Landing Gear with Wheels & Wheel Pants
FPM307006	Wing and Stab Tube Joiner Set
FPM307007	Pushrod Set
FPM37708	Red/Black Decal Set
FPM37709	Green/Black Decal Set
FPM307010	Spinner
FPMA0003	Plastic Clevis Set (10)
FPMP11545E	SR 11.5 x 4.5E Propeller
FPZM1010C	Potenza 10 1400kv Motor (3S)
FPZM1010A1	5mm Collet Prop Adapter
FPZM1010A2	Potenza 10 Aluminum X-Mount with Screws
FPZM1010A3	Potenza 10 5mm Motor Shaft with Collar
FPZA1016	Potenza Advanced LED Controller
ZTW50ABEC	ZTW 50A ESC 3S/6S with 8A BEC
FPZAURA08ZZE300G2	Potenza Aura 8 AFCS for QQ 300G2
FPZAU02	Aura Micro-USB to USB Cable

OPTIONAL ACCESSORIES

FPZAU01	Potenza 3pc. Male-Male Servo Connectors
FPZB22003S45	Potenza 3S 2200mAh 45C Li-Po
FPZB26003S45	Potenza 3S 2600mAh 45C Li-Po
FPZM1010D	Potenza 10 1070kv Motor (for 4S batteries)
FPMPAPC1245MR	APC 12x4.5 MR Propeller (for 4S)
FPZB22004S40	Potenza 4S 2200mAh 40C Li-Po
FPZB26004S45	Potenza 4S 2600mAh 45C Li-Po
FPZA1010	Potenza Digital Battery Analyzer
ZTWCARD	ZTW ESC Programming Card
SPMAR8010T	Spektrum AR8010T DSMX Receiver
SPM9745	Spektrum DSMX Remote Receiver <small>(Recommended SPM Receiver)</small>
FUTR2001SB	R2001SB S.BUS S-FHSS Receiver <small>(Recommended FUT Receiver)</small>
FUTR7003SB	R7003SB S.BUS FASSTest Receiver
FUTT6K	Futaba T6K Transmitter w/R3006SB Receiver

COMPLETION ITEMS

INSTALLED!		Potenza 10 1400 Kv Brushless Outrunner Motor (FPZM1010C)
INSTALLED!		ZTW 50A ESC with 5V/8A BEC (ZTW50ABEC)
INSTALLED!		Potenza DS15 Digital Servos (FPZDS15)
INSTALLED!		Aura 8 Advanced Flight Control System (FPZAURA08ZZE300G2)
INCLUDED!		11.5 x 4.5 Electric SR Propeller (FPMP1145E)
NEEDED TO COMPLETE		2100-3300mAh 3S 11.1V 35C+ Li-Po (FPZB22003S45)
NEEDED TO COMPLETE		6+ Channel Computer Transmitter
NEEDED TO COMPLETE		Spektrum DSMX Remote Receiver(s) Spektrum SRXL Futaba S.Bus Hitec S.Bus Graupner SumD, JR XBus Mode B Jeti UDI 12 6+ Channel Receiver (any brand)

BATTERY CHARGING GUIDELINES

⚠ WARNING

FOLLOW ALL INSTRUCTIONS PROVIDED BY YOUR BATTERY AND CHARGER MANUFACTURER. FAILURE TO COMPLY CAN RESULT IN FIRE.

The assembly of the QQ Extra 300G2 can be accomplished in less than one hour. Prior to assembling the airplane, it is advisable to charge your battery so that you are ready to begin setup upon completion of the assembly of your model.

We recommend the use of an advanced Li-Po balancing charger for your batteries to get the maximum performance and lifespan.

Our airplanes are designed around our Potenza Li-Po batteries, and we recommend the Potenza 3S 2200mAh 45C Li-Po based on our extensive testing and development. These batteries feature an EC3 connector, so no soldering is required for use in your QQ Extra 300G2.

All are available at www.flexinnovations.com

SPECIAL LANGUAGE DEFINITIONS

The following terms are used throughout the product literature to indicate various levels of potential harm when operating this product:

- NOTICE:** Procedures, which if not properly followed, create a possibility of physical property damage AND a little or no possibility of injury.
- CAUTION:** Procedures, which if not properly followed, create the probability of physical property damage AND a possibility of serious injury.
- WARNING:** Procedures, which if not properly followed, create the probability of property damage, collateral damage, and serious injury OR create a high probability of serious injury.

WARNING

AGES 14+

This product is not intended for use by children under 14 years without direct adult supervision.

ATTENTION

Read the ENTIRE instruction manual to become familiar with the features of the product before operating. Failure to assemble or operate the product correctly can result in damage to the product, personal property, and cause serious or fatal injury.

All instructions, warranties and other collateral documents are subject to change at the sole discretion of Flex Innovations, Inc. For up-to-date product literature, please visit our website at www.flexinnovations.com and click on the appropriate product pages.

IMPORTANT INFORMATION REGARDING WARRANTY

Please read our Warranty and Liability Limitations section before building this product. If you as the Purchaser or user are not prepared to accept the liability associated with the use of this Product, you are advised to return this product immediately in new and unused condition to the place of purchase.

SAFETY WARNINGS AND PRECAUTIONS

Protect yourself and others by following these basic safety guidelines.

1. This manual contains instructions for safety, operation and maintenance. It is essential to read and follow all the instructions and warnings in the manual, prior to assembly, setup or use, in order to operate correctly and avoid damage or serious injury.
2. This model is not a toy, rather it is a sophisticated hobby product and must be operated with caution and common sense. This product requires some basic mechanical ability. Failure to operate this product in a safe and responsible manner could result in injury or damage to the product or other property.
3. This model must be assembled according to these instructions. Do not alter or modify the model outside of these instructions provided by Flex Innovations, Inc. as doing so may render it unsafe and/or unflyable. It is your responsibility to ensure the airworthiness of the model.
4. Inspect and check operation of the model and all its components before every flight.
5. If you are not an experienced pilot or have not flown a high-performance model before, it is recommended that you seek assistance from an experienced pilot in your R/C club for your first flights. If you're not a member of a club, the Academy of Model Aeronautics (AMA) has information about clubs in your area whose membership includes experienced pilots.
6. Keep the propeller area clear from such items as loose clothing, jewelry, long hair, or tools as they can become entangled. Keep your hands and body parts away from the propeller as injury can occur.
7. Never fly in visible moisture, or submerge the airplane or any of its electronic components in water. Permanent damage to electronic components may occur, or corrosion of components may lead to intermittent failures.

LOW VOLTAGE CUTOFF

Li-Po batteries have a nominal (rated) voltage of 3.7V per cell, and fully charged, reach 4.2V per cell. Batteries are designed to be discharged below the nominal voltage, however, if they are discharged below 3.0V per cell, damage will occur and the pack will lose capacity. For best long term battery life, set a timer and land after a time that leaves approximately 15% of the battery's capacity remaining.

Low voltage cutoff is a feature that is built into the ZTW 50A ESC that is designed to protect the connected battery from being discharged too far and causing permanent damage to the cells. Circuitry within the ESC will automatically detect when the input voltage from the battery pack reaches below 3.15V per cell (average) and will remove power to the motor, but still deliver power to the servos so that a safe landing may be made. If the motor begins to lose power rapidly during flight, the LVC has sensed that the total voltage of the pack has dropped below 3.15V per cell average, and the airplane should be landed immediately.

MAIN LANDING GEAR INSTALLATION

Required Tools and Fasteners:

#1 Phillips Screwdriver
(4) M3x10 Phillips Head Self-Tapping Screw



1. Insert the landing gear assembly into the slot in the bottom of the fuselage. The landing gear will sweep forward as it moves away from the fuselage.
2. Insert the landing gear retaining plate over the landing gear and into the slot in the fuselage, and secure it with the (4) M3x10 Phillips Head self-tapping screws.

TECH TIP: For added support and longevity in the event of hard landings, you can apply some clear silicone into the landing gear slot prior to inserting the landing gear into the fuselage. Once the landing gear has been inserted into the fuselage, apply more silicone before securing the retaining plate to the fuselage. The landing gear can still be removed easily for repair or replacement.



OPTIONAL WHEEL PANT REMOVAL

For pilots that want the lightest possible setup, or for those that fly off of unimproved fields, the wheelpant on the QQ Extra 300G2 are removable. Two wheel collars have been provided in the hardware bag to retain the wheels after the wheelpants are removed.

Required Tools and Fasteners:

#1 Phillips Screwdriver
1.5mm Hex Driver
(2) Wheel Collars

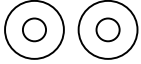

1. Invert the airplane and locate the two wheel pant retaining screws and remove them. Slide the wheel pant and wheel off the axle.
2. Remove the wheel from the wheel pant and reinstall on the axle.
3. Slide the wheel collar onto the axle with the shoulder (offset) towards the wheel. Apply blue thread lock on the setscrew and tighten.



TAIL WHEEL INSTALLATION

Required Tools and Fasteners:

#1 Phillips Screwdriver
(3) M3x10 Phillips Head Self-Tapping Screw

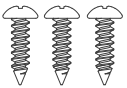

1. Insert the tailwheel assembly into the slot in the bottom of the rudder.
2. Install the tailwheel retaining plate over the tailwheel wire, and secure it in place with the (3) M3x10 Phillips head self-tapping screws.



AURA 8 AFCS

The Aura 8 Advanced Flight Control System (AFCS) installed in your QQ Extra 300G2 is a giant leap forward in aircraft flight control system technology. Compatible with virtually every receiver on the market today, the Aura features special configuration for DSM systems via remote receiver connection(s), and serial data connection for Futaba or Hitec S.Bus, Spektrum SRXL, Graupner HOTT (Sum D of 8), JR XBus (Mode B), and Jeti UDI12 (standard) systems, as well as being compatible with traditional receivers via PWM servo connections.

The Aura 8 advanced flight control system in your QQ Extra 300G2 has been pre-tuned for ease of use, eliminating many hours of tedious setup. For the latest Aura features, programs, transmitter downloads, and instructions, please visit wiki.flexinnovations.com/wiki/Aura

The Aura is programmable through any Windows based PC or tablet. All dual rate, expo, travel, and assignable mode programs are adjusted inside the Aura through the PC application. An assignable master gain that is OFF by default can be enabled by the Aura application. If desired, assign CH 8/AUX 3 on a proportional dial or slider.

By default, CH5/Gear is used to select the 3 flight modes by 3 position transmitter switch. CH6/Aux 1 is used to select the on/off position of the LED controller by 2 position transmitter switch (night version only).

- Works conveniently with all major radio systems
- Accepts signals from DSM Remote Receiver(s), Spektrum SRXL, Futaba S.Bus, Graupner Hott (Sum D of 8), JR XBus (Mode B), Jeti UDI12 (standard), Hitec S.Bus, PPM Stream, or any brand of receiver via male to male servo connectors
- Expertly tuned and ready to use
- USB port allows loading model configurations, user programming, and firmware updates (cable included)
- Flexible and extensive programming through Windows-based PC or tablet
- 3+ flight modes allow precise or aggressive settings to be selected in flight
- 3-axis gyro utilized in QQ Extra 300G2 programming

Visit wiki.flexinnovations.com/wiki/Aura for the latest Aura-related product information and tips for your particular radio brand.

Description of Pre-Loaded Aura Flight Modes (FM)

Mode 1 (Gyro Off): Rates are set for general flight (same as Sport Mode). Exponential is tuned for comfortable flight.

Mode 2 (Sport Mode): Gains are moderate and tuned for comfortable feel/best performance for precision aerobatics. Aileron and elevator rates are low and expo is tuned for comfortable flight.

Mode 3 (3D Mode): Gains are highest and tuned for 3D aerobatics. Rates are set to highest. Exponential is tuned for comfortable flight.

Each of the modes has been tuned by our team to offer a solid start. Because tastes in control feel are unique, if changes in rates and expo are needed, adjustments should be made through the Aura.

Changes in gain value can only be made through the Aura.

NOTICE

DO NOT PROGRAM THESE VALUES INTO YOUR TRANSMITTER!

The shown Aura 8 settings are pre-configured and the unit is ready to use. The chart shown is for informational purposes only. No additional action is required to fly the airplane.

REFERENCE ONLY: Aura Settings

		Mode 1	Mode 2	Mode 3
Aura 8 Rate Setup	Aileron	◀▶ 40%	◀▶ 40%	◀▶ 100%
	Elevator	◀▶ 23%	◀▶ 23%	◀▶ 100%
	Rudder	◀▶ 95%	◀▶ 95%	◀▶ 95%
		Mode 1	Mode 2	Mode 3
Aura 8 Expo Setup	Aileron	◀▶ 30%	◀▶ 15%	◀▶ 30%
	Elevator	◀▶ 25%	◀▶ 10%	◀▶ 25%
	Rudder	◀▶ 30%	◀▶ 25%	◀▶ 25%

⚠ WARNING

DO NOT ATTEMPT RADIO SETUP WITH PROPELLER INSTALLED. INADVERTENT POWER UP COULD CAUSE DEATH OR SERIOUS INJURY.

TRANSMITTER SETUP

The Aura 8 AFCS is designed to work seamlessly with all major transmitter and receiver brands. When programming your transmitter, start with a freshly reset new model memory in your transmitter. **Make ONLY the changes shown in the Transmitter Configuration Guide unless otherwise noted.**

The Aura 8 in the QQ Extra 300G2 defaults to 3 flight modes that are switched via CH5/Gear in your transmitter. You may need to reassign CH5/Gear to a 3-position switch.

The LEDs in the Night QQ Extra 300G2 are switchable on/off via CH6/Aux 1 in your transmitter. You may need to reassign CH6/Aux 1 to a 2-position switch.

Consult your transmitter manual if you have questions on how to change the switch or channel assignments.

The Aura comes pre-programmed with dual rates and expos specifically designed for the QQ Extra 300G2. For large (greater than 5%) changes in expo or dual rates, it is highly recommended to reset all expos and rates to default in the transmitter, and tune through the Aura Config Tool.

The Aura Config Tool is free to download, and can be used on any Windows-based PC or tablet. Download at:

www.flexinnovations.com/AuraConfigTool

TRANSMITTER CONFIGURATION GUIDE		
	Spektrum, Futaba & Graupner	JR DMSS ¹
Wing/Tail Type	Normal - 1 Ail, 1 Ele, 1 Rud	Normal - 1 Ail, 1 Ele, 1 Rud
End Points (Travel Adjust or ATV)	Ail/Ele/Rud 125%	Ail/Ele/Rud 88%
	Thro/Gear/Aux1 100%	Thro/Gear/Aux1 88%
Reversing	None Required²	None Required
Sub Trim	Verify at zero, NOT ALLOWED	Verify at zero, NOT ALLOWED
Trim Levers	Verify at zero	Verify at zero
CH. 5 (Gear)	Assigned to a 3-position switch	Assigned to a 3-position switch
CH. 6 (Aux1)	Assigned to a 2-pos. switch (for LEDs)³	Assigned to a 2-pos. switch (for LEDs)³
Timer ⁴	Set to 3:30 for initial flights	

1. JR transmitter users that use Spektrum DSM2/DSMX receivers should follow the Spektrum information in the chart above.
2. If you are using a Futaba transmitter, please note that some Futaba transmitters have the throttle set to reversed by default. Leave reversing set to defaults to start, and reverse as needed.
3. This is only required to switch the LEDs on/off via the transmitter. If the LED controller is unplugged from the receiver or Aura 8, the lights default in the ON position when powered.
4. The QQ Extra 300G2 can fly anywhere between 3 and 6 minutes (w/3S 2200mAh Li-Po), depending on flying style.

NOTICE

FOR CUSTOMERS USING TRANSMITTERS OTHER THAN WHAT IS LISTED IN THE CHART ABOVE, PLEASE VISIT OUR WIKI PAGE FOR INSTRUCTIONS SPECIFIC TO YOUR TRANSMITTER AND RECEIVER BRAND

JETI	wiki.flexinnovations.com/wiki/Aura/JetiUse
HITEC	wiki.flexinnovations.com/wiki/Aura/HitecSbusUse
FRSKY	wiki.flexinnovations.com/wiki/Aura/FrSkyUse

CONNECTING A BATTERY/ARMING THE ESC

Observe the following procedures to safely power up your model after it has been bound. **Ensure propeller is removed unless sequence is followed to power up before flight.**

1. Lower the throttle stick and trim to their lowest setting and turn on the transmitter. Wait for your transmitter to indicate the radio signal is being broadcast before proceeding.

If a battery is connected to the ESC with the throttle fully open on the active transmitter, the ESC will enter programming mode. If this occurs, simply disconnect the battery, lower the throttle, and reconnect the battery.

2. Ensure the aileron, elevator and rudder gimbals are centered.
3. With the airplane on a solid surface, connect the battery to the ESC and wait. The ESC will make the motor emit a series of audible tones during its initialization process.
4. The ESC will make the motor emit a short, final tone sequence indicating that the ESC is now armed, and that the motor will spin in response to throttle stick movement.

! WARNING

When making adjustments to linkages, transmitter settings or the Aura 8 flight control system, remove the propeller to guard against accidental spool up.

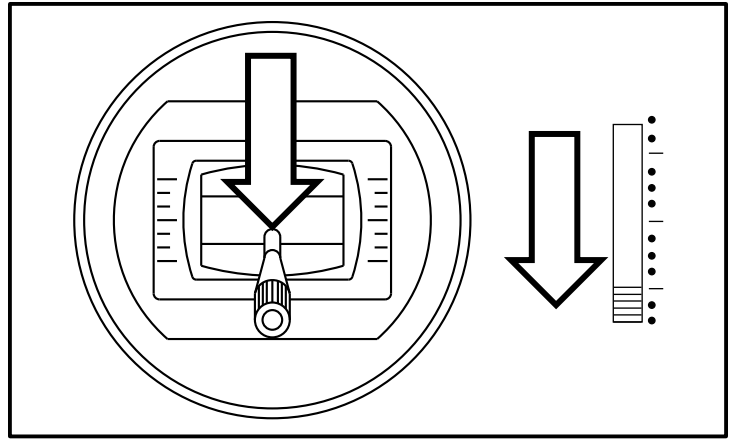

! CAUTION

Always connect the battery when the throttle stick and throttle trim is in the idle/cut-off position.

! WARNING

Hold the aircraft securely when connecting the battery before flight. Always ensure the propeller is clear of any and all objects as they may become entangled.

CONNECTING A BATTERY TO THE LED CONTROLLER (NIGHT VERSION ONLY)

The LEDs on your QQ Extra 300G2 are switchable via the transmitter, and are designed to be powered by 12 volts (3S Li-Po) through the 6S JST-XH balance tab on the LED controller. By default, the LED controller is plugged into Aura Port S7, which uses CH6/AUX1 from the transmitter for control. Assign CH6/AUX1 in your transmitter to a 2-position switch for control of the LEDs. **If the servo lead of the LED controller is not plugged into the Aura or a receiver, the LEDs will default in the ON position, allowing the QQ Extra 300G2 (Night Version) to be flown at night with a basic 5-channel transmitter or receiver.**

The LEDs should be powered from the flight battery per the diagram below.

! WARNING

The LEDs use approximately 1.2A from ONLY 3 cells of the battery powering it. If using a higher cell count battery for power, 3 of the cells will have a lower voltage than the others at the end of each flight. Leave excess voltage in the battery at the end of each flight to prevent the over-discharging of the cells that power the LEDs. **You MUST balance charge** your batteries after each flight the LED controller is powered by anything other than a 3 cell battery.

! WARNING

Do not leave the battery plugged into the LED controller for extended periods of time. Doing so can damage the battery.

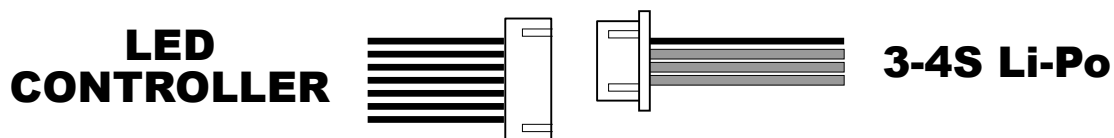

RECEIVER INSTALLATION/SERVO CONNECTIONS

Aura will auto-detect modern digital receiver connection(s). Using a modern digital receiver connection gives the Aura access to precise data of each channel for additional gyro-enabled outputs, simplifies wiring, and allows for more advanced features. To connect a modern digital receiver connection, follow the steps on pages 10 or 11 (depending on your receiver type), then skip ahead to page 13.

For traditional PWM receivers without digital connection(s), male to male servo leads must be used for each channel. Please refer to the connection diagram on page 12.

Supported Modern Data-Linked Receivers

Aura will auto-detect these modern digital receiver connections:

Spektrum Remote Receiver(s)	Spektrum SRXL
Futaba or Hitec S.Bus	JR XBus (Mode B)
Graupner HOTT (Sum D of 8)	Jeti UDI12 (standard)*

A PPM (8CH, negative shift, approximately 22ms/frame) receiver may also be connected into Port 'B', however Aura will not auto-detect and setup must be performed through the Aura Config Tool (Windows Application).

DEFAULT AURA CONNECTIONS

S1	Throttle (ESC/BEC)
S2	Left Aileron
S3	Right Aileron
S4	Elevator
S5	Rudder
S6	(Empty)
S7	LED Controller
S8	(Empty)

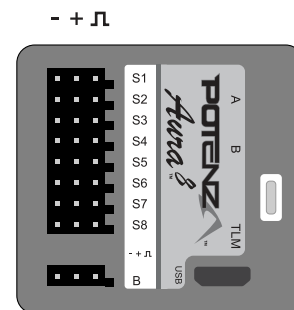

For specific information on receiver types and our recommended receivers for this aircraft, please visit the QQ Extra 300G2 Wiki page at the below URL:

wiki.flexinnovations.com/wiki/QQExtra300G2

Connecting Your Receiver to Aura

Spektrum Remote Receivers

1. Connect one Spektrum Remote Receiver to Mini Port 'A' at the top of the Aura case. If using two, connect the second to Mini Port 'B'.

2. To bind a DSMX Spektrum Remote Receiver connection, insert a bind plug into Aura Port S8. **Port 'B' is NOT for binding.**

To bind a DSM2 Spektrum Remote Receiver connection, insert a bind plug into Aura port S1 AND S8.

If you are unsure which type of DSM remote receiver you have, start by attempting the bind process with a bind plug in S8. If you continue to have trouble binding, then insert one bind plug in S1, and one bind plug in S8.

3. Connect the flight battery to the ESC, and the remote receivers should begin to flash, indicating that they are ready to bind. Bind from here as recommended by your transmitter manufacturer.

4. Confirm the remote receiver(s) is(are) bound by verifying a solid LED on the receiver.

Aura will then automatically begin the Auto-Detect process, indicated by sweeping LEDs on the Aura. Once found, you will see a solid orange (power and calibrated sensor) and solid green (valid receiver data) LED on the Aura indicating the Aura is in its flight-ready state.

5. Mount your receivers using double sided foam tape, or hook and loop tape. Consult your receiver manual for proper mounting orientations and procedures.

If you are using a traditional Spektrum receiver, with either a digital connection type or with PWM connections, DO NOT plug any remote receivers into the Aura 8. They should instead be plugged directly into your traditional receiver.

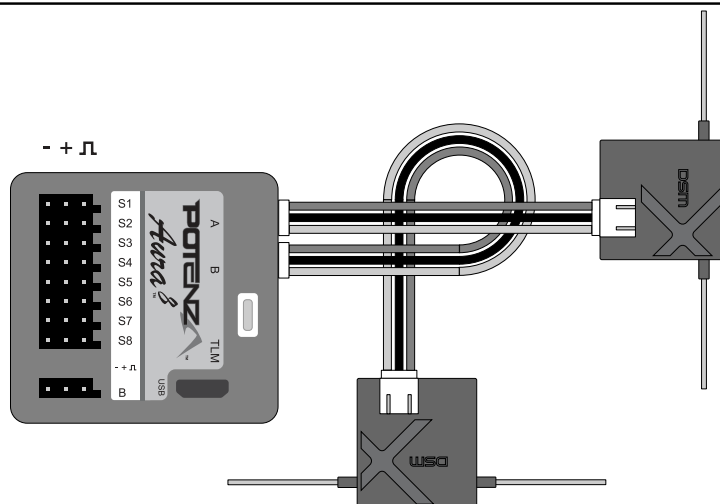

Note: It may be necessary to move the ESC lead to another open port (such as 'Port B') during the binding procedure. Be sure to return the ESC lead back to S1 after binding is complete.

Note: There are many JR-branded remote receivers that use Spektrum DSM2 and DSMX RF protocol. For these, follow the instructions for Spektrum remote receivers.

RECEIVER INSTALLATION/SERVO CONNECTIONS (CONTINUED)

All Other Digital Receiver Connections

1. While Spektrum and Futaba usually output their digital data stream, it may be necessary for JR DMSS, Graupner HOTT, and Jeti users to program the transmitter/receiver to output the correct digital format listed on the previous page. Consult your transmitter and receiver manuals for further details.
2. Bind your transmitter and receiver per your manufacturer's instructions.
3. Connect the included male to male servo extension to the receiver's data port (ex: S.Bus, SRXL etc.) and connect to servo port 'B' on the face of the Aura. Refer to your radio manufacturer's instructions for specific information on appropriate serial port connections and system settings.

If your receiver has a working throttle port while using it's digital connection, use it. Move the ESC (throttle) lead from Aura Port S1 to your receiver's throttle port. Consult your receiver and/or transmitter instruction manual for specific details on your system.

4. With the transmitter powered, power up the aircraft. Aura will search (sweeping LEDs) and lock onto the signal. You will then see solid orange (power and calibrated sensor) plus solid green (valid radio source), and have control of the model.

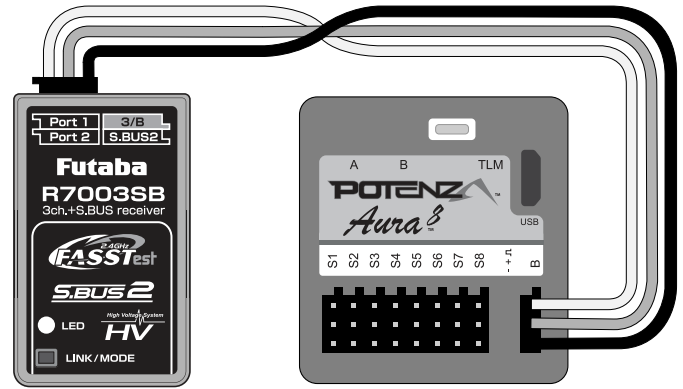

Note: If you are using Futaba S.Bus, be sure to use the proper S.Bus port in your receiver. DO NOT use the S.Bus 2 port, as it is not supported for use with the Aura 8. Refer to your manufacturer's instructions for proper S.Bus use.

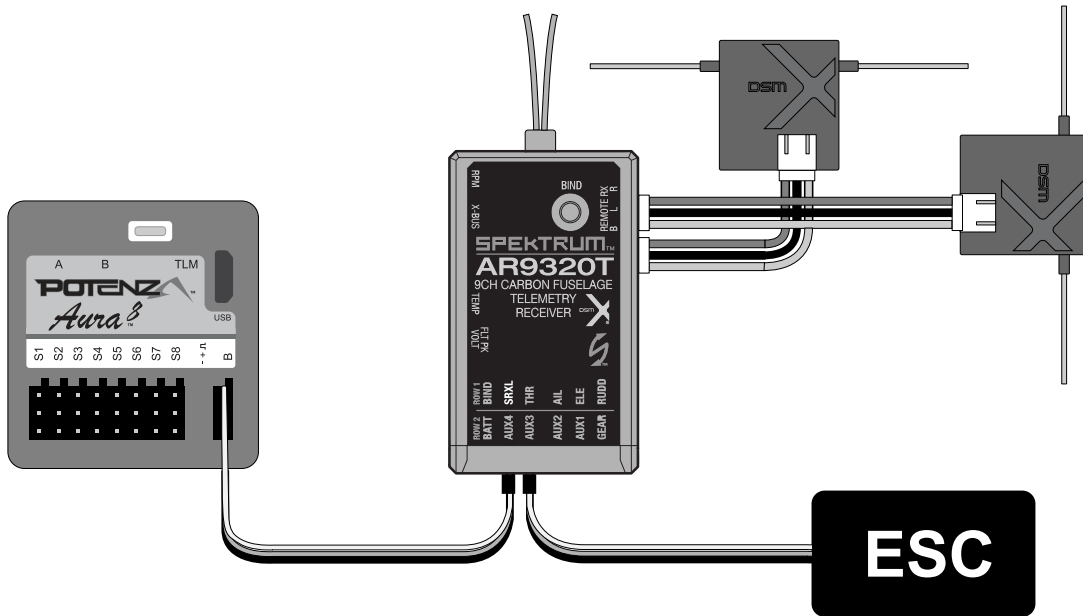

Note: When using Spektrum SRXL to connect to the Aura, always connect the remote receivers to the Spektrum receiver, NOT to the Aura.

RECEIVER INSTALLATION/SERVO CONNECTIONS (CONTINUED)

Connecting a Traditional Receiver to Aura with PWM Servo Connections

PWM is an acronym which stands for Pulse Width Modulation. A servo will move to a specific angle in a specific direction based on the width of the signal pulse it receives. Most transmitters output a total pulse width of 1.1-1.9ms, with the midpoint being 1.5ms. Lower pulse widths will move the servo to one side of neutral and higher pulse widths to the other side of neutral. Different from serial data connections (S.Bus, SRXL etc.) this is how traditional receivers work. In order to utilize this type of receiver connection with your QQ Extra 300G2, male to male servo leads to connect the corresponding receiver ports to Aura are required. A minimum 5-channel receiver is required to set up Aura with PWM servo connections. **Please purchase FPZAU01 Aura 3-piece male to male servo cable/S.Bus to complete the PWM connection setup.**

1. Bind your receiver to your transmitter by following the instructions provided by your transmitter and receiver manufacturer. Verify that it is bound by connecting a spare servo to the receiver and verify that it responds to the appropriate input.
2. With the transmitter and receiver powerd OFF, connect your receiver to Aura using the diagram below. Note that the throttle is plugged directly into the receiver. Depending on your particular transmitter, you may need to reverse the throttle in the transmitter when the ESCs throttle lead is plugged directly into your receiver.

NOTICE

VERIFY PROPER POLARITY OF ALL CABLE CONNECTIONS PRIOR TO ADDING POWER TO THE SYSTEM

All four (4) PWM male to male connections must be connected AND connected in the proper polarity from receiver outputs to Aura inputs for Aura to activate servo outputs. (Aileron - S1, Elevator - S2, Rudder - S3, Gear/CH5 - S4)

3. With the propeller removed and ALL connections made (observing correct polarity), power on your transmitter and the airplane with the flight battery, ensuring that the airplane is kept stationary. After a few seconds, the LEDs on Aura will sweep back and forth as Aura searches for a valid control signal. Once found, a solid orange (aura Running), and solid green (Aura receiving valid signal from the receiver) LED is illuminated. After the source is found, **apply transmitter right rudder** to assist Aura to determine your radio type, after which point control of the model is established. This is only required during initial setup

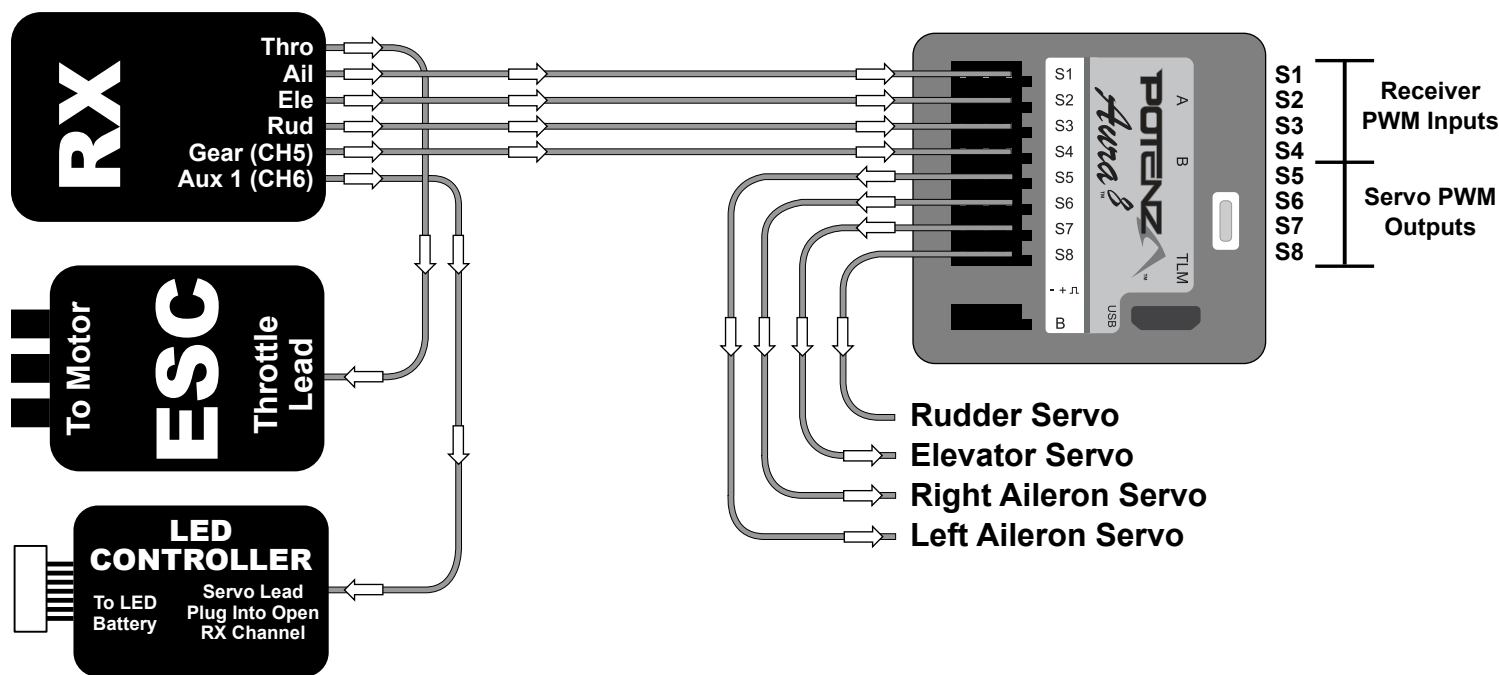

Note: The LEDs on the QQ Extra 300G2 Night Version are able to be turned on and off via a channel from your transmitter. For PWM users, simply plug the servo lead from the LED controller into any open channel on your receiver (such as CH6/AUX1), and assign that channel to a 2-position switch on your transmitter accordingly.

If you do not have an available channel on your transmitter and/or receiver for the LED controller, you can simply leave the servo lead unplugged, and the lights will be on by default (once powered). Be sure to secure the wiring to the fuselage.

If you are using a traditional Spektrum receiver, with remote receivers, DO NOT plug any remote receivers into the Aura 8. They should instead be plugged directly into your traditional receiver.

HORIZONTAL STABILIZER INSTALLATION

Required Tools and Fasteners: Clear Tape (4 Pieces, Included)

1. Insert the horizontal stabilizer tube into the fuselage and roughly center.
2. Slide the left and right stabilizer halves onto the tube. Ensure that the control horn orients towards the belly of the airplane and that the elevator joiner tabs are properly indexed. Do not force the stabilizer into place.
3. Apply four (4) pieces of clear tape to the joint between the stabilizer and the plastic mounts. Be sure to apply tape to both the top and bottom of each stabilizer.
4. Attach the clevis to the elevator control horn in the proper hole per the diagram below. Slide the clear tubing over the clevis ends to secure it in place.

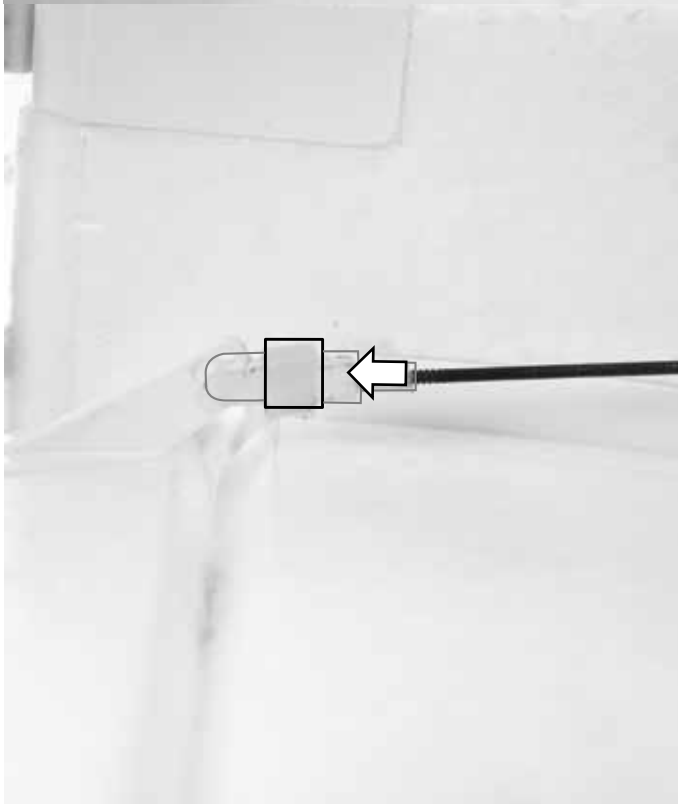
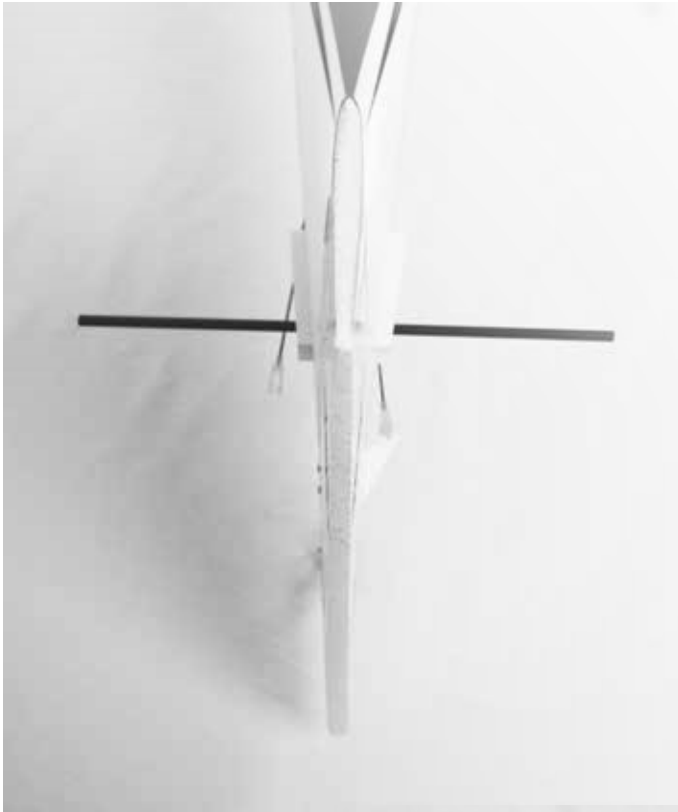

Servo Arms			
Elevator	Rudder	Elevator	Rudder

MAIN WING INSTALLATION

Required Tools and Fasteners: #1 Phillips Screwdriver
(2) M3x25 Self-Tapping Screws

1. Invert the airplane so that the belly is facing up. Remove the belly hatch by pulling the exposed tab away from the fuselage.
2. Install the wing tube into the fuselage.
3. Slide the left or right wing panel on the wing tube and guide the servo wire and LED wire (night version only) into the fuselage.
4. Secure the wing to the fuselage with one (1) M3x15 self-tapping screw. Push the wing tube completely into the wing until it stops. Do not force it into place.
5. Slide the other wing panel on the wing tube and guide the servo wire into the fuselage. Seat the wing to the fuselage completely, but do not force it into place.
6. Plug the left aileron servo wire into the S2 port of the Aura, and the right aileron servo wire into the S3 port of Aura. Connect the LED wires directly to the LED controller.

NOTICE

Occasionally there may be some flashing left inside the wing tube support rings inside the wing panels. This flashing may prevent the wing tube from seating fully into the wing. You can remove this flashing with a hobby knife or a dowel wrapped with some 300 grit sand paper. Do NOT shorten the wing tube, as it relies on this outer ring for structural support.

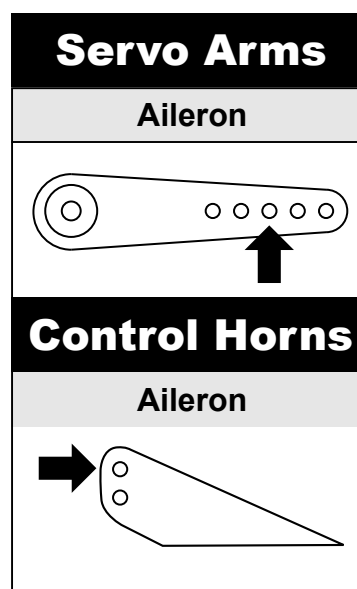
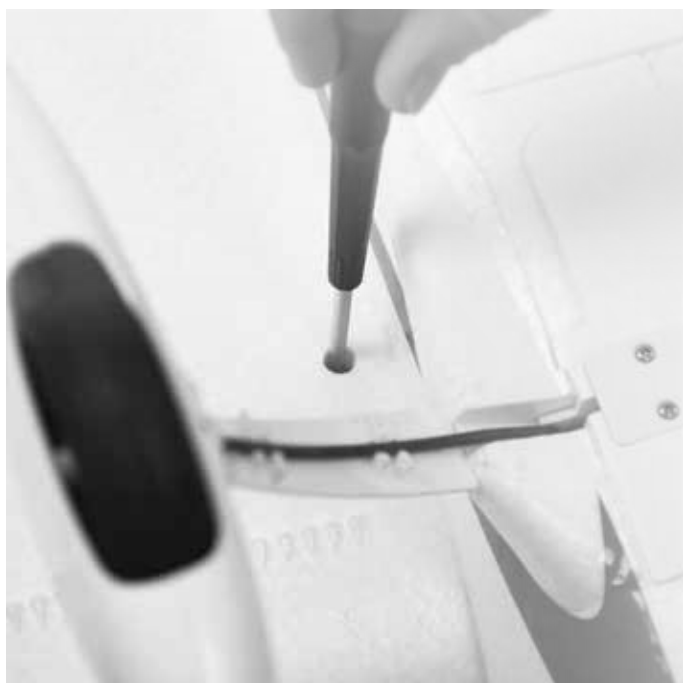

SFG INSTALLATION

Required Tools and Fasteners: Medium CA

1. If you have a night version, remove the backing from the adhesive strip on the exposed LEDs in the wing tip. Place both LED strips on the side of the SFG that faces the fuselage, along the long edge of the SFG. One should be placed above the wing, and the other should be placed below the wing. NOTE: The plastic skid on the SFG should be oriented toward the ground with the aircraft upright.
2. Liberally apply medium CA to the airfoil-shaped mounting tab on the inside of the SFG.
3. Insert the SFG into the molded cavity in the wingtip and press tightly. NOTE: The plastic skid on the SFG should be oriented toward the ground with the aircraft upright.

LED Light Strip Locations

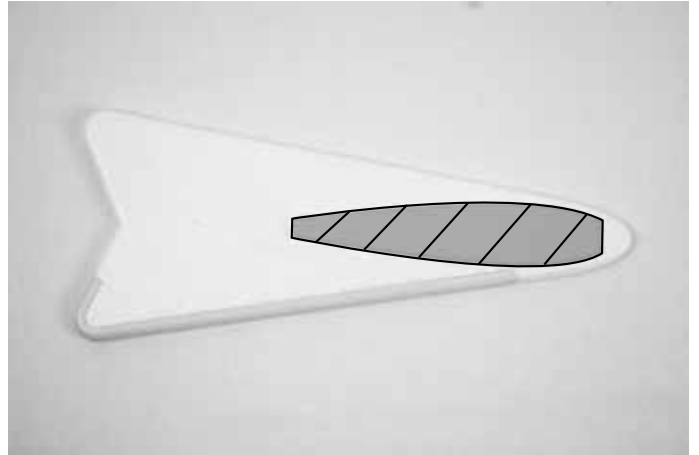
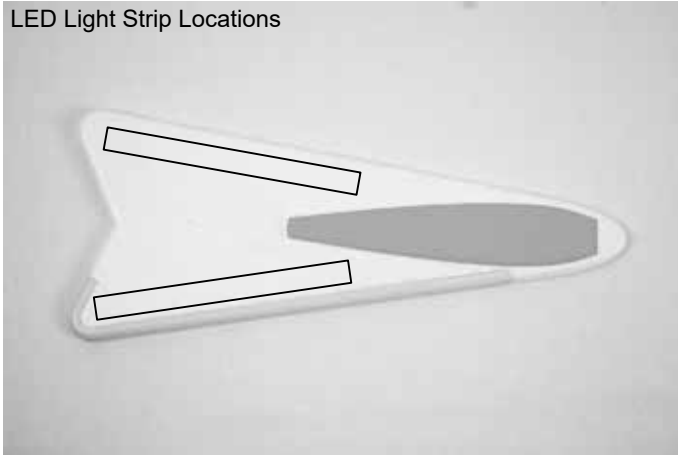

BATTERY INSTALLATION

1. Pull the spring loaded latch away from the nose, and lift the rear of the hatch off the fuselage.
2. Install adhesived-backed hook and loop tape to both the battery and the battery tray.
3. Place the battery in the battery tray and secure it with the provided hook and loop strap. Use the image below to reference the location of the recommended battery.
4. Re-install the hatch, and confirm the latch has positively engaged.

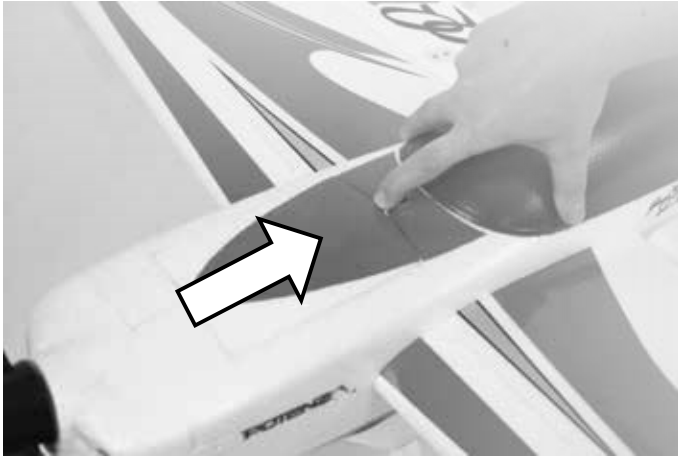

⚠ CAUTION

Always keep limbs clear from the propeller when the battery is connected. After the ESC arms, the propeller will rotate when the throttle is moved. Unlike an internal combustion engine, electric motors apply more voltage to counteract resistance, therefore any object that is entangled in the propeller will be severely damaged before the motor will stop.

⚠ WARNING

When making adjustments to linkages, transmitter settings, or the Aura 8 Flight Control System, remove the propeller to guard against accidental spool up.

TRANSMITTER CONTROL DIRECTION TEST

Refer to the chart below to determine the proper control surface directions.

If controls are reversed, DO NOT REVERSE CONTROLS IN THE TRANSMITTER OR THE AURA CONFIG TOOL. Email us at support@flexinnovations.com for corrective action. Note that BOTH the Transmitter Control Direction Test AND the Flight Controller Sensor Direction Test MUST BOTH BE PASSED! IF ONE DOES NOT PASS, DO NOT FLY!

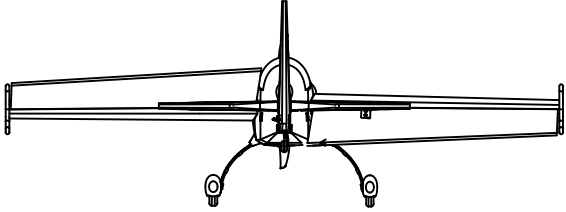
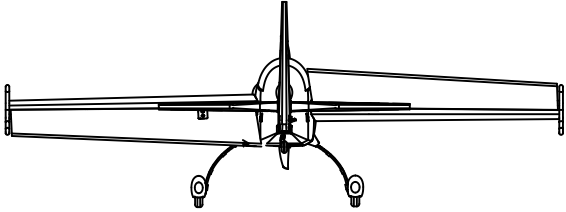
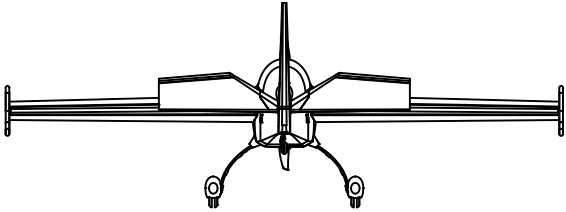
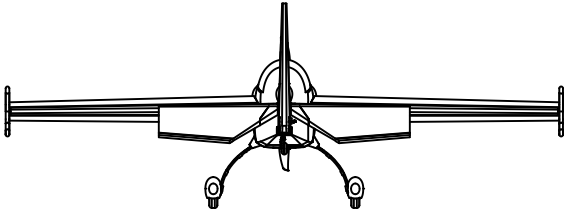
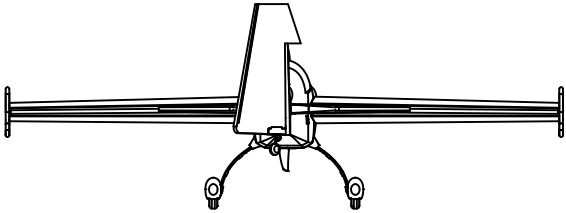
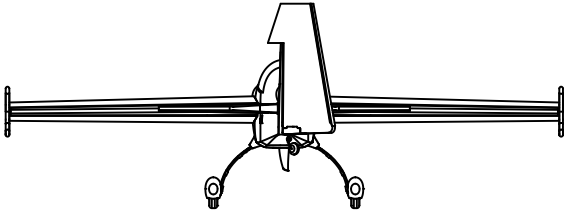
		Stick Movement	Proper Control Surface Deflection
AILERON	Stick Left		
	Stick Right		
ELEVATOR	Stick Aft		
	Stick Forward		
RUDDER	Stick Left		
	Stick Right		

AURA SENSOR DIRECTION TEST

Perform a test of the gyro system to verify the corrections made for a given movement are correct. If any of the tests do not result in the correct reaction for the airplane's gyro system, **DO NOT FLY THE AIRPLANE**, and contact us by email at support@flexinnovations.com or by phone at (866) 310-3539.

The flight control system activates with RF broadcast. Perform these tests in Mode 3 (higher gain) for better visibility, and then again in Mode 2, and any other flight modes that have gyro gains assigned. (By default, Mode 1 has no gain assigned.) Control surface deflections are exaggerated in the drawings below for clarity. Please note that the control surfaces will move **ONLY** while the aircraft is **ROTATING**.

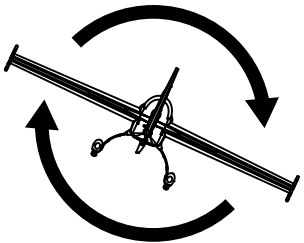
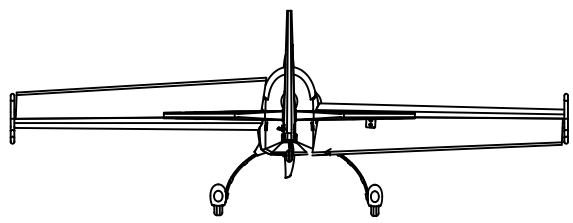
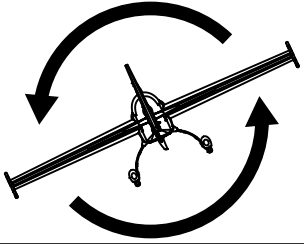
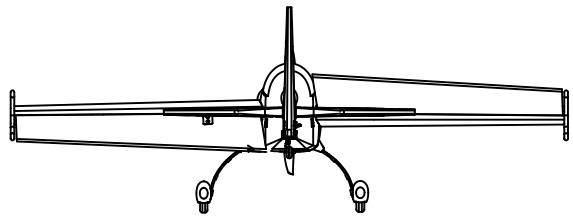
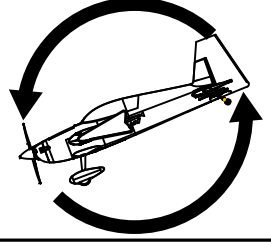
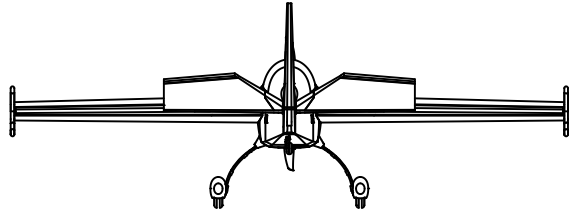
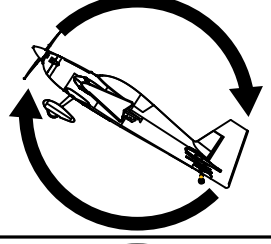
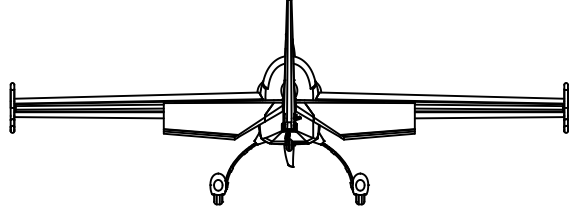
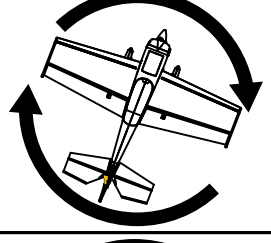
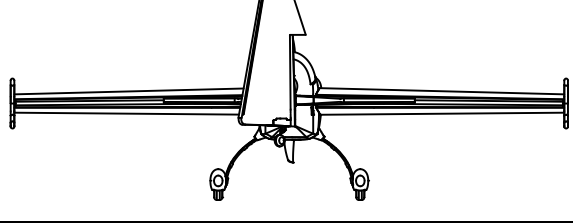
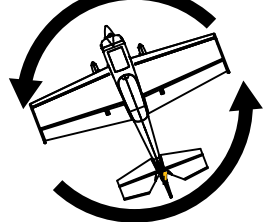
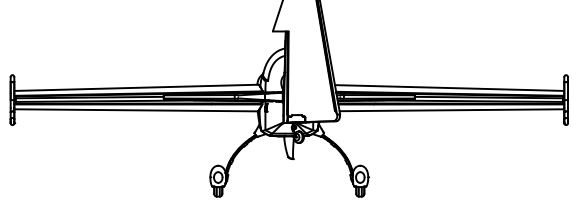
		Aircraft Movement	Proper Control Surface Deflection
AILERON			
			
ELEVATOR			
			
RUDDER			
			

PROPELLER AND SPINNER INSTALLATION

Required Tools and Fasteners:

M3x6 Phillips Head Screw (1)
M8 Nut
M8 Prop Washer

#1 Phillips Screwdriver
14mm or Adjustable Wrench

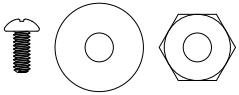

1. Insert the prop collet onto the motor shaft. Ensure that it is fully seated.
2. Temporarily remove the prop nut and washer and install the propeller with the convex surface facing outward. The propeller size numbers are printed on the front face of the propeller and should orient forward.
3. Slide the prop washer on the collet with the widest face toward the tail of the airplane and tighten the prop nut.
4. Slide the spinner over the prop collet and seat it fully. Use the M3x6 screw to secure the spinner to the prop collet.

NOTICE

Because the spinner does not have a backplate, spin the motor by hand to ensure that the spinner rotates true.

NOTICE

The QQ Extra 300 has a decent amount of up thrust in the motor. This angle is intentional for flight performance.



CENTER OF GRAVITY VERIFICATION

The center of gravity (CG) location for the QQ Extra 300G2 is **aligned with the front edge of the lower belly hatch**. This location was determined from many test flights by designer and multi-time world aerobatic champion, Quique Somenzini. Lift the airplane from the underside of the wing to check CG.

Setting the center of gravity is one of the most important steps for success, particularly with a new airplane. The QQ Extra 300G2 is a high-performance airplane with large control surface throws, and a high thrust-to-weight ratio. These two factors combined make it a very enjoyable aircraft to fly, but if the CG is not within an acceptable range, it will make the aircraft difficult, if not impossible to control.

NOTICE

The CG measurement should be made with the completed airframe with all components (batteries, servos, receiver, linkages, hardware, etc.) installed. Failure to do so will result in an inaccurate measurement.

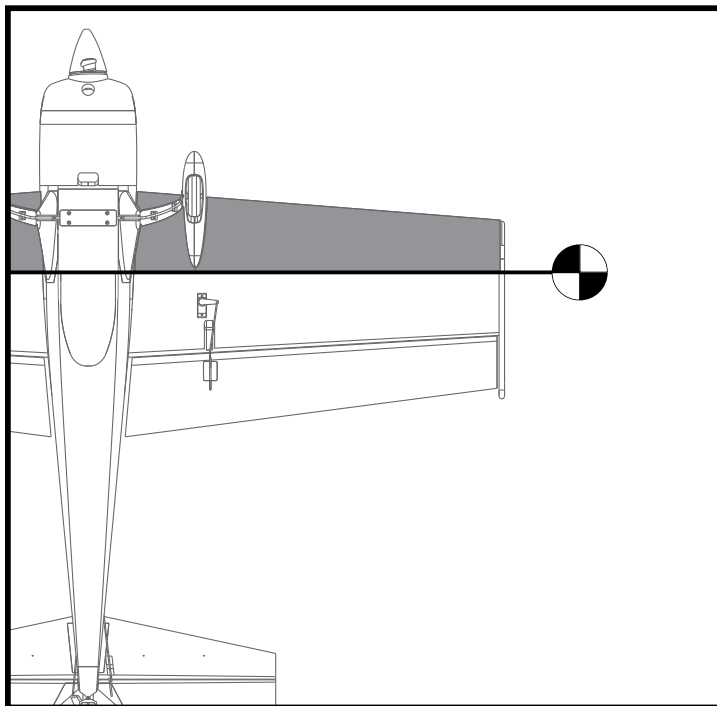

PRE-FLIGHT CHECKS

To help ensure a successful first flight, as well as many flights after, perform a few simple pre-flight checks to ensure the aircraft is ready for flight.

1. Verify control surfaces are properly hinged and in good working order. Pinch a control surface between your thumb and fore finger, and stabilize the wing with your other hand. Give the control surface a firm pull away from the wing. The control surface should not come unhinged from the wing. Be sure to avoid over-stressing the part, as an aggressive pull may cause the surface to come unhinged even though it is hinged properly. **If hinging is loose, do not fly.** Apply thin CA to the loose side(s) of the hinge(s) to resecure.
2. Verify that all hardware and all other aircraft parts are properly secured. This includes hardware and parts installed by the factory.
3. Verify your battery is fully charged and in good working condition. Avoid using batteries with swollen cells, or batteries that do not charge back to their full capacity.
4. Verify the CG is in the proper location, and the battery is well secured in place.
5. Ensure the Aura is on and functioning properly. Power on your transmitter, followed by the aircraft. Ensure the Aura is calibrated properly and receiving a valid radio source (solid orange + solid green LEDs). Verify that the Aura is secured well to the airframe.
6. Verify transmitter stick inputs result in the proper control surface movements (reference page 17).
7. Verify aircraft movement results in proper Aura sensor corrections (reference page 18).
8. Verify the motor and ESC function properly. Point the aircraft in a safe direction, and away from any objects or limbs that could become entangled in the propeller. Hold the aircraft firmly so that you are behind the aircraft. Smoothly advance the throttle to full and back to idle. Listen and watch for any odd or unusual behavior from the motor and ESC.

FLYING YOUR QQ EXTRA 300G2

Selecting a Flying Site

Selecting a flying site is critical to a successful flight. Airplanes require a lot more room than other R/C products, therefore, a neighborhood or parking lot is not recommended. A local AMA field is the best location for flying your QQ Extra 300G2. If no AMA field is available in your area, a large open field with short grass and generous overfly area is the best candidate. Know your overfly area. Ensure that there are no houses, playgrounds, people or other buildings that may be damaged if the airplane were to crash.



Takeoff

Taxi or place the aircraft on the runway centerline, with the nose pointed into the wind. Select Mode 2, then set throttle trim so that the motor spins at it's lowest RPM without stopping. Smoothly advance the throttle to full while maintaining directional control with the rudder and slight up pressure on the elevator. The airplane should lift off smoothly before the throttle is fully open. Fly in Flight Mode 2 until the aircraft is fully trimmed (see special trimming instructions), and you are comfortable with it's handling, then explore the other modes as desired.

Flying

Altitude is your friend on the first flight. Briskly climb to a safe altitude and trim the airplane. The airplane should fly straight and level at 1/2-3/4 power with no input from the sticks. Try some basic maneuvers, and slowly progress into the airplane's flight envelope as you become more comfortable with the airplane's flight qualities and perfect your setup. **Note: if at any time, such as after gain adjustments, you experience unexpected control system inputs or oscillations, switch to Mode 1, and land and troubleshoot the issue. (Mode 1 turns the sensor inputs off with default programming)**

Landing

Be mindful of your flight time and allow adequate battery reserve for a couple of landing attempts, if necessary, on the first few flights. Select Flight Mode 2 and slow the airplane and align with the runway, into the wind. Keep the throttle at 1/8-1/4 power for the majority of the decent. The airplane should descend smoothly in this configuration with proper airspeed. Once you are close to the ground, gradually close the throttle fully and begin to smoothly apply up elevator as required to arrest descent and the airplane should gently touch down with a short roll out. **Remember, you can always smoothly advance the throttle to full, and make a go-around to set up for another landing.** You don't have to land on the first attempt.

Trimming

The first several flights on your QQ Extra 300G2 should be dedicated to trimming and setup. Fly the airplane at 2/3 power in Flight Mode 2 and trim for level flight. Land, adjust linkages and return the trim to zero, and fly again. Repeat until the airplane flies hands off, straight and level. Transmitter trim or sub-trim will cause trim shifts when different flight modes are selected. To eliminate this trim shift, you can mechanically trim the model, or you can complete Aura "Quick Trim".

Aura Quick Trim

The Aura 8 features a Quick Trim Mode that eliminates the need for mechanical linkage adjustments during test flights. Aura will learn the trim values from your transmitter, and apply them to the control surfaces at power up when enabling quick trim mode.

NOTE: Quick Trim can also be used BEFORE flying to make small changes to center the control surfaces before flight.

NOTE: ENSURE AILERON/ELEVATOR/RUDDER TRANSMITTER SUB-TRIMS ARE ZERO BEFORE FLYING FOR QUICK TRIM PROCESS

NOTE: QUICK TRIM IS NOT AVAILABLE TO PWM CONNECTION USERS. IF YOU ARE USING A PWM CONNECTION, YOU WILL NEED TO **MECHANICALLY TRIM THE MODEL.**

1. Fly the airplane in Flight Mode 2. Trim the aircraft with the transmitter and land. **DO NOT CHANGE FLIGHT MODES.**
2. Power off the Aura. Insert a bind plug into **Aura Port S3** (you will need to remove the servo lead that is currently in S3). Check the transmitter is on and repower the Aura.
3. Wait 5 seconds for the Aura to completely initialize. Confirm Quick Trim mode is active by checking the Blue LED is slowly flashing.
4. Remove the bind plug from **Aura Port S3**, and re-install the servo that was previously removed into S3. Removing the bind plug stores the current trims in the Aura. The Blue LED will flash quickly after control surface trim values are stored. While the trim values are stored in Aura, they are not applied to the control surface(s) until the Aura is repowered.
5. Remove power from the Aura and center all control surface trims on the transmitter.
6. Re-power the Aura. The control surfaces should be unchanged even though the trim has been centered on the Transmitter. Switch between other Flight Modes to ensure you do not see any changes in trim.

CAUTION

USE CAUTION WHEN FLYING YOUR QQ EXTRA 300G2 IN FLIGHT MODE 3 AT HIGH AIRSPEEDS. DOING SO CAN INDUCE CONTROL SURFACE OSCILLATIONS AND MAY CAUSE A CRASH.

AIRFRAME REPAIRS

The QQ Extra 300G2 is molded from durable EPO foam and is repairable with most adhesives. Similar to building and repairing wood or composite aircraft, the correct glue for a given application is critical to the repair holding and not breaking again. For major repairs, such as a broken fuselage, epoxy is preferred because it allows time to correct any misalignment, and is less brittle than CAs. For smaller repairs, such as a cracked control surface or small chunk of material missing from the airframe, regular CA is very effective. The use of odorless (foam safe) CA is not recommended on EPO foam because it is weaker than regular CA and takes a longer period of time to cure.

NOTE: Avoid the use of CA accelerant in repairs. It can damage paint and will weaken the bond of the glue. If CA accelerant is used, be mindful of the locations of CA to prevent premature bonding of parts or bonding a hand or clamp to the airframe.

If a part is damaged too badly to be repaired, please refer to page 3 of this manual for a complete listing of available replacement parts.

NOTICE

If a crash is imminent, fully reduce the throttle to prevent further damage to the power system and reduce energy to lessen impact damage. Never allow the propeller to contact the ground under power, even at a slow idle.

CRASH DAMAGE IS NOT COVERED UNDER WARRANTY

NOTE: Avoid keeping the aircraft in direct sunlight when not flying. Excessive heat can damage the airplane's structure, and UV light can permanently discolor decals.

REPLACING SERVOS

Required Tools and Fasteners: #1 Phillips Screwdriver

1. Disconnect the servo from the Aura 8.
2. Unscrew the servo arm screw from the servo, and remove the servo arm.
3. Unscrew the two servo mounting screws of the servo and remove.

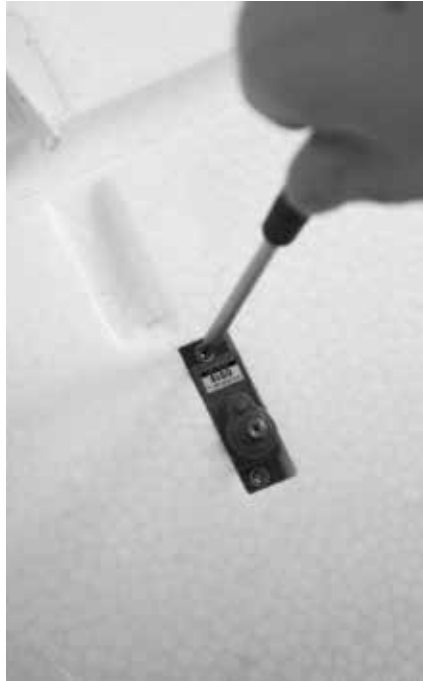

TIP: Plug a spare servo extension into the servo lead before removing to make it easier to install the lead of the servo when replaced.

SERVICING THE POWER SYSTEM

Required Tools and Fasteners: #1 Phillips Screwdriver
M3 Hex Driver

1. Following the installation instructions in reverse, remove the spinner, propeller and collet adapter from the motor.
2. Use a #1 Phillips screwdriver to remove the cowling screws from the plastic tabs on the side of the fuselage.
3. Pull the plastic tabs away from the fuselage, and remove the cowling from the fuselage.
4. Remove the (4) bolts holding the motor to the firewall using a #1 Phillips screwdriver. Disconnect the motor from the ESC.
5. To remove the ESC, disconnect the ESC from the receiver or the Aura 8, and remove any cable ties holding the ESC to the fuselage.



AIRCRAFT TROUBLESHOOTING GUIDE

Should you encounter any abnormal situations with your aircraft or it's installed electronics, refer to the matrix below to determine probable cause and a recommended solution for the action.

If the required solution does not rectify the problem, please contact product support for further assistance.

⚠ NOTICE

Unless specifically required, ALWAYS troubleshoot the airplane with the propeller removed.

DISCREPANCY	PROBABLE CAUSE	RECOMMENDED SOLUTION
Motor nonresponsive (ESC initialization tones audible)	Throttle not at idle and/or throttle trim too high	Lower throttle stick and trim completely. If problem persists, ensure that the sub-trim and travel adjust are properly set in the radio's programming.
	Throttle channel is reversed	Reverse throttle channel in radio programming.
	No signal from receiver or Aura	Verify transmitter is broadcasting signal and is bound to receiver
Motor nonresponsive (No ESC initialization tones audible)	Motor disconnected from ESC	Ensure plugs are fully seated. Check battery and/or plugs for damage and replace any damaged components found. DO NOT ATTEMPT TO REPAIR.
Motor turns in the wrong direction	The three motor wires are connected incorrectly to the ESC	Swap any TWO motor wires.
Reduced flight time or aircraft under powered	Flight battery not fully charged	Ensure battery is fully charged prior to installing in aircraft.
	Propeller installed backwards	Install the propeller so that the convex side faces forward.
	Flight battery is weak or damaged	Remove battery from service and replace with a different battery.
	Ambient temperature is too cold	Ensure battery packs are adequately warm (70°F/21°C) before flight.
	Battery capacity too small for intended use	Replace battery with one of proper capacity and discharge capacity (C rating).
	ESC reaching preset LVC (low-voltage cutoff)	Recharge battery, or reduce flight time.
Excessive propeller noise and/or vibration	Battery's discharge rating too low	Replace battery with one of a higher discharge rating.
	Damaged spinner, propeller, prop adapter or motor	Replace damaged components. DO NOT ATTEMPT REPAIR.
	Propeller is not balanced	Balance or replace the propeller.
	Prop nut is loose	Tighten prop nut with properly sized wrench.
	Spinner is not fully in place or tightened	Loosen the spinner bolt, adjust as required and retighten bolt.
Control surface(s) non-responsive	Propeller nut or propeller adapter threads not cut straight	Replace propeller nut or propeller shaft. DO NOT ATTEMPT REPAIR.
	Airframe or control linkage system damaged	Replace damaged control system components. DO NOT ATTEMPT REPAIR.
	Transmitter model bound incorrectly, incorrect active model memory, incorrect Aura data input configuration, incorrect transmitter settings	Consult radio manual for proper binding and model selection instructions.
	Battery voltage too low	Use volt meter to check battery. Replace or recharge as necessary.
	Battery disconnected from ESC	Verify that battery is connected, and that the EC plugs are fully seated.
Failed control direction test	Battery Eliminator Circuit (BEC) damaged	Replace ESC. DO NOT ATTEMPT REPAIR.
	Damaged servo	Replace servo. DO NOT ATTEMPT REPAIR.
Control surface oscillation	Incorrect transmitter or Aura 8 setting. DO NOT FLY!	Reference transmitter and receiver sections of this manual. If no solution is found, contact customer support at support@flexinnovations.com .
	Exceeding maximum airspeed for configuration	Reduce airspeed.
	Propeller/spinner not balanced	Balance or replace spinner/propeller.
	Motor vibration	Inspect motor and motor mounting. Tighten screws as needed or replace motor.
	Loose Aura 8 Mounting	Realign and secure the Aura 8 to the aircraft.
	Excessive control linkage slop or play	Inspect control linkage system and replace components as necessary.
	Improper transmitter setup	Refer to the transmitter configuration guide in this manual to properly configure transmitter settings.
	Damaged spinner and/or propeller	Replace spinner and/or propeller as needed. DO NOT ATTEMPT REPAIR.
Improperly set master gain	Ensure master gain is set for proper gain value(s).	
Trim changes between flight modes	Trims are not properly zeroed	Use Aura "Quick Trim" feature, or mechanically trim the model and reset transmitter trim to zero.
	Sub-trims are not properly zeroed	Use Aura "Quick Trim" feature, or mechanically trim the model and reset transmitter sub-trim to zero.
	Transmitter is out of calibration (aileron/elevator/rudder are not at neutral with sticks centered; reference transmitter monitor screen)	Calibrate transmitter (reference transmitter's instruction manual) or return transmitter to manufacturer for calibration.
PWM Receiver Connection type, and cannot get orange + green LED on Aura, and no control of model	Any of the four PWM cables not connected	Connect all four male to male servo cables between your receiver and Aura.
	Any of four PWM cables connected to incorrect ports	Connect all cables to the proper ports. Reference the diagram on the PWM receiver connections page of this manual.
	Polarity of any PWM cables incorrect	Reconnect servo cables with the proper polarity.
	Receiver not bound and/or not outputting PWM servo pulses	Bind receiver per manufacturer's instructions and verify with a servo to ensure PWM signal is output from each channel as required.

LIMITED WARRANTY

Warranty Coverage

Flex Innovations, Inc. and its authorized resellers ("Flex") warrant to the original purchaser that the product purchased (the "Product") it will be free from defects in materials and workmanship at the date of purchase.

Outside of Coverage

This warranty is not transferable and does not cover:

- (a) Products with more than 45 days after purchased date.
- (b) Damage due to acts of God, accident, misuse, abuse, negligence, commercial use, or due to improper use, installation, operation or maintenance
- (c) Modification of or to any part of the Product.
- (d) Product not compliant with applicable technical regulations.
- (e) Shipping damage
- (f) Cosmetic damage
- (g) Products that have been partially, or fully assembled

OTHER THAN THE EXPRESS WARRANTY ABOVE, FLEX MAKES NO OTHER WARRANTY OR REPRESENTATION, AND HERBY DISCLAIMS ANY AND ALL IMPLIED WARRANTIES, INCLUDING, WITHOUT LIMITATION, THE IMPLIED WARRANTIES OF NONINFRINGEMENT, MERCHANTABILITY AND FITNESS FOR A PARTICULAR PURPOSE. THE PURCHASER ACKNOWLEDGES THAT THEY ALONE HAVE DETERMINED THAT THE PRODUCT WILL SUITABLY MEET THE REQUIREMENTS OF THE PURCHASER'S INTENDED USE.

Purchaser's Solution

Flex's sole obligation and purchaser's sole and exclusive remedy shall be that Flex will, at its option, either (i) service, or (ii) replace, any Product determined by Flex to be defective. Flex reserves the right to inspect any and all Product(s) involved in a warranty claim. Service or replacement decisions are at the sole discretion of Flex. Proof of purchase is required for all warranty claims. **SERVICE OR REPLACEMENT AS PROVIDED UNDER THIS WARRANTY IS THE PURCHASER'S SOLE AND EXCLUSIVE REMEDY.**

Limitation of Liability

FLEX SHALL NOT BE LIABLE FOR SPECIAL, INDIRECT, INCIDENTAL OR CONSEQUENTIAL DAMAGES, LOSS OF PROFITS OR PRODUCTION OR COMMERCIAL LOSS IN ANY WAY, REGARDLESS OF WHETHER SUCH CLAIM IS BASED IN CONTRACT, WARRANTY, TORT, NEGLIGENCE, STRICT LIABILITY OR ANY OTHER THEORY OF LIABILITY, EVEN IF FLEX HAS BEEN ADVISED OF THE POSSIBILITY OF SUCH DAMAGES.

Further, in no event shall the liability of Flex exceed the individual price of the Product on which liability is asserted. As Flex has no control over use, setup, assembly, modification or misuse, no liability shall be assumed nor accepted for any resulting damage or injury. By the act of use, setup or assembly, the user accepts all resulting liability. If you as the purchaser or user are not prepared to accept the liability associated with the use of the Product, purchaser is advised to return the Product immediately in new and unused condition to the place of purchase.

Law

these terms are governed by Florida law (without regard to conflict of law principals). This warranty gives you specific legal rights, and you may also have other rights which vary from state to state. **FLEX RESERVES THE RIGHT TO MODIFY THIS WARRANTY AT ANY TIME WITHOUT PRIOR NOTICE.**

Questions & Assistance

Visit www.flexinnovations.com/articles.asp?ID=269 to find customer support in your region.

Inspection or Services

If this Product needs to be inspected or serviced and is compliant in the region you live and use the Product in, please contact your regional Flex authorized reseller. Pack the Product securely using a shipping carton. Please note that original boxes need to be included, but are not designed to withstand the rigors of shipping without additional protection. Ship via a carrier that provides tracking and insurance for lost or damaged parcels, as Flex is not responsible for merchandise until it arrives and is accepted at our facility.

Warranty Requirements

For Warranty consideration, you must include your original sales receipt verifying the proof of purchase date, original packaging materials, including the shipping carton. Provided warranty conditions have been met, your Product will be replaced free of charge. Shipping charges are as follows: shipping to Flex paid by customer, shipping to customer paid by Flex. Service or replacement decisions are at the sole discretion of Flex.

COMPLIANCE INFORMATION FOR THE EUROPEAN UNION



Declaration of Conformity (In accordance with ISO/IEC 17050-1)

Product(s): QQ Extra 300G2 Super PNP Red
QQ Extra 300G2 Super PNP Green
QQ Extra 300G2 Night Super PNP Red
QQ Extra 300G2 Night Super PNP Green

Item Number(s): FPM3770A
FPM3770B
FPM3780A
FPM3780B

The object of declaration described above is in conformity with the requirements of the specifications listed below, following the provisions of the EMC Directive 2004/108/EC.

EN 55022: 2010+AC:2011
EN 55024: 2010
EN 61000-3-2: 2006+A2:2009
EN 61000-3-3: 2013

EN 61000-6-3: 2007/A1:2011
EN 61000-6-1: 2007



Instructions for disposal of WEEE by users in the European Union

This product must not be disposed of with other waste. Instead, it is the user's responsibility to dispose of their waste equipment by handing it over to a designated collections point for the recycling of waste and electronic equipment. The separate collection and recycling of your waste equipment at the time of disposal will help to conserve natural resources and ensure that it is recycled in a manner that protects human health and the environment. For more information about where to drop off your waste equipment for recycling, please contact your local city office, your household waste disposal service or where you purchased this product.



Academy of Model Aeronautics National Model Aircraft Safety Code

Effective January 1, 2018

- A. GENERAL:** A model aircraft is a non-human-carrying aircraft capable of sustained flight in the atmosphere. It may not exceed limitations of this code and is intended exclusively for sport, recreation, education and/or competition. All model flights must be conducted in accordance with this safety code and any additional rules specific to the flying site.
- Model aircraft will not be flown:
 - In a careless or reckless manner.
 - At a location where model aircraft activities are prohibited.
 - Model aircraft pilots will:
 - Yield the right of way to all human-carrying aircraft.
 - See and avoid all aircraft and a spotter must be used when appropriate. (AMA Document #540-D.)
 - Not fly higher than approximately 400 feet above ground level within three (3) miles of an airport without notifying the airport operator.
 - Not interfere with operations and traffic patterns at any airport, heliport or seaplane base except where there is a mixed use agreement.
 - Not exceed a takeoff weight, including fuel, of 55 pounds unless in compliance with the AMA Large Model Airplane program. (AMA Document 520-A.)
 - Ensure the aircraft is identified with the name and address or AMA number of the owner on the inside of affixed to the outside of the model aircraft. (This does not apply to model aircraft flown indoors.)
 - Not operate aircraft with metal-blade propellers or with gaseous boosts except for helicopters operated under the provisions of AMA Document #555.
 - Not operate model aircraft while under the influence of alcohol or while using any drug that could adversely affect the pilot's ability to safely control the model.
 - Not operate model aircraft carrying pyrotechnic devices that explode or burn, or any device which propels a projectile or drops any object that creates hazard to persons or property.

Exceptions:

- Free Flight fuses or devices that burn producing smoke and are securely attached to the model aircraft during flight.
 - Rocket motors (using solid propellant) up to a G-series size may be used provided they remain attached to the model during flight. Model rockets may be flown in accordance with the National Model Rocketry Safety Code but may not be launched from model aircraft.
 - Officially designated AMA Air Show Teams (AST) are authorized to use devices and practices as defined within the Team AMA Program Document. (AMA Document #718.)
- Not operate a turbine-powered aircraft, unless in compliance with:
 - the AMA turbine regulations. (AMA Document #510-A.)
 - Model aircraft will not be flown in AMA sanctioned events, air shows or model demonstrations unless:
 - The aircraft, control system and pilot skills have successfully demonstrated all maneuvers intended or anticipated prior to the specific event.
 - An inexperienced pilot is assisted by an experienced pilot.
 - When and where required by rule, helmets must be properly worn and fastened. They must be OSHA, DOT, ANSI, SNELL or NOCSAE approved or comply with comparable standards.

B. RADIO CONTROL (RC)

- All pilots shall avoid flying directly over unprotected people, vessels, vehicles or structures and shall avoid endangerment of life and property of others.
- A successful radio equipment ground-range check in accordance with manufacturer's recommendations will be completed before the first flight of a new or repaired model aircraft.
At all flying sites a safety line(s) must be established in front of which all flying takes place. (AMA Document #706.)
 - Only personnel associated with flying the model aircraft are allowed at or in front of the safety line.
 - At air shows or demonstrations, a straight safety line must be established.
 - An area away from the safety line must be maintained for spectators.
 - Intentional flying behind the safety line is prohibited.

- RC model aircraft must use the radio-control frequencies currently allowed by the Federal Communications Commission (FCC). Only individuals properly licensed by the FCC are authorized to operate equipment on Amateur Band frequencies.
- RC model aircraft will not knowingly operate within three (3) miles of any pre-existing flying site without a frequency-management agreement. (AMA Documents #922 and #923)
- With the exception of events flown under official AMA Competition Regulations, excluding takeoff and landing, no powered model may be flown outdoors closer than 25 feet to any individual, except for the pilot and the pilot's helper(s) located at the flightline.
- Under no circumstances may a pilot or other person touch an outdoor model aircraft in flight while it is still under power, except to divert it from striking an individual.
- RC night flying requires a lighting system providing the pilot with a clear view of the model's attitude and orientation at all times. Hand-held illumination systems are inadequate for night flying operations.
- The pilot of an RC model aircraft shall:
 - Maintain control during the entire flight, maintaining visual contact without enhancement other than by corrective lenses prescribed for the pilot.
 - Fly using the assistance of a camera or First-Person-View (FPV) only in accordance with the procedures outlined in AMA Document #550.
 - Fly using the assistance of autopilot or stabilization system only in accordance with the procedures outlined in AMA Document #560

C. FREE FLIGHT

- Must be at least 100 feet downwind of spectators and automobile parking when the model aircraft is launched.
- Launch area must be clear of all individuals except mechanics, officials, and other fliers.
- An effective device will be used to extinguish any fuse on the model aircraft after the fuse has completed its function.

D. CONTROL LINE

- The complete control system (including the safety thong where applicable) must have an inspection and pull test prior to flying.
- The pull test will be in accordance with the current Competition Regulations for the applicable model aircraft category.
- Model aircraft not fitting a specific category shall use those pull-test requirements as indicated for Control Line Precision Aerobatics.
- The flying area must be clear of all utility wires or poles and a model aircraft will not be flown closer than 50 feet to any above-ground electric utility lines.
- The flying area must be clear of all nonessential participants and spectators before the engine is started.

If you are not an AMA member, please consider joining. Founded in 1936 and open to anyone interested in model aviation, the AMA is the governing body for model aviation in the United States and sanctions over 2,000 competitions annually. Membership in the AMA provides liability insurance coverage, protects modelers' rights and interests, and is required to fly at most of the 2,700+ R/C sites nationwide.

Academy of Model Aeronautics
5161 East Memorial Drive
Muncie, IN 47302-9252
Toll Free (800) 435-9262
Fax (765) 741-0057

www.modelaircraft.org



©2018 Flex Innovations, Inc.
Premier Aircraft™, Potenza™, and Top Value RC™ are trademarks or registered trademarks of Flex Innovations, Inc.
DSM®, DSM2™, and DSMX™ are trademarks or registered trademarks of Horizon Hobby LLC
Futaba™ is a registered trademark of Futaba Denshi Kogyo Kabushiki Kaisha Corporation of Japan.
Jeti™, UDI, and Jeti Model are trademarks or registered trademarks of Jelen, Ing. Stanislav of Czech Republic
Hitec is a trademark or registered trademark of Hitec RCD USA Inc.
Graupner HoTT® is a registered trademark of Graupner Co., Ltd.